



MONITORING THE GRAIN STORAGE SYSTEM USING IOT

2792

Dr. Madhura K^{1*}, Dr. K. Balakrishnan², Ms. Ayushi Chaudhary³

Assistant Professor^{*1}, Associate Professor², Assistant Professor³

Presidency University^{*1}, Sambhram Institute of Technology², Sanskar College of Engineering and Technology³
madhura@presidencyuniversity.in^{1*}, balakrishnank88.official@gmail.com², ayushichaudhary11@gmail.com³

I. OVERVIEW

A growing country like India is rich in cultivation field and most of the Indian population rely on farming and dairy. The development and storage of grains in large quantity supports Indian economy. The process of grain storage includes collection of grain, controlling temperature, protecting from bugs, tracking wetness and controlling the level of carbon dioxide. The conventional strategies are obliged to just evaluating the temperature and clamminess specifications which are sensibly in converse as novel elements must be checked and found unreservedly for including to their compelling accumulating and backing. The proposed strategy involves the checking grain storage system in an intelligent manner consistently and is conscious through IoT devices and sensors. Furthermore, the Blynk cloud utility will perseveringly invigorate the structure by means of notification in constant time stamps. The exploratory outcomes of the experiment are displayed on the smart grain amassing board system. A proposed in this paper comprises of an assortment of angles like electronic disclosure, regular updation and simple structure support. This deals with the outstanding component of set aside grain and diminishes the grain wastage for the length of capacity range, work and guide thought.

Keywords: IOT, sensor, Arduino, Blynk, Hardware, Software.

DOI Number: 10.48047/NQ.2022.20.20.NQ109272

NeuroQuantology2022;20(20): 2792-2807

II. INTRODUCTION

In several international locations Grains are the integral wellspring of meals and many staple meals gadgets are geared up from them, so each and every human existence be counted upon Grains meals gadgets for patience in both ways.

Henceforth improvement and ability of grains has overwhelming importance in financial system of use and through and massive development of the commonplace public. Economies of created and agricultural international locations be counted straightforwardly or by way

of implication upon potential of developed grains because they are recognized with the few extremely good many individuals. Keeping up with restriction temperature, gorgeous moistness and relative carbon dioxide content material in the potential local weather are the great troubles. The variances in occasional and each and every day local weather influence the nature of grain and these are motivations to construct structure development, creepy crawly exercises. Inside the warehouse, the structure improvement occurs at round 25-30°C part temperature, worm improvement and



propagation occurs at perfect temperature of 15°C or more. Creepy crawly metabolic motion in dry stockpiling beneath 15% dampness content material can convey about warming up to 42°C. A central factor that provides to the grain deterioration is improvement of distinct structure species which discharge mycotoxins. Organisms produce everyday synthetics regarded mycotoxins that are unsafe to grain wellbeing. These workouts discharge CO₂ fuel in the put away grain. Henceforth, CO₂ fixation is the profitable component to figure out the early decay segment of put away grain. Shape Activity: Stored grain for the most section get contaminated through the tremendous assortments of shape at precise degree. Temperature and Moisture will beautify mildew improvement and diminishes the nature of put away grain. The form discharges mycotoxins which therefore builds grouping of CO₂ in the course of capacity. Invasion: The temperature of put away grain is continuously multiplied by way of Insect action. Bug propagation brings about in heat grain. Henceforth positive ascent in temperature can be the crook investigator measure in opposition to creepy crawly development.

The task of Intelligent Grain Storage Management will give that colossal method of holding up with the grains set aside in authoritative or individual stockrooms in incredible substance with keeping up with up with their refreshing degree and with considerably less wastages. The structure will screen, recognize, look at and deal with that heap of accidents occurring in the warehouses. The made item will help with watching the warehouse through the particular sensors and microcontroller that will mirror the records on the work place structure thus. As demonstrated with the guide of that data, the manager or train will come to perceive the specifications inside the stockroom. On the off hazard that the substance showed on work district structure is past the space substance, he can find the astounding strategies to improve

the organization. Furthermore, the Blynk programming will determinedly supply the admonitions to the distant owner or the chief with regards to the stockroom. In the competition that if there should happen a commonness of any fiasco like heater or spillage, etc. happens then the oversee structure will supply the pre-arranged notification to the watchman with the guide of turning on the sign. As, the temperature, sogginess and barometrical gases expects immense stage in the improvement of bugs internal the set aside grain, thusly watching the level of this elements inside warehouses will be the statute objective of this system. The temperature above 15°C (Celsius) will be great situation for the improvement of bugs; accordingly, the system will keep up with up with the grain amassing continually under that confine temperature. Also, on the off danger that the animal enters the warehouse, the sensor will hold onto the undesired propensities inside warehouse and will notice the regulator about such bothersome segment. This heap of exercise schedules will effectively help the seller with keeping up with up with the capability of grain at good situation aside from their setback and with significantly less aide thought.

1.1. REQUISITE EXAMINATION:

SYSTEM METHODOLOGY:

a. Device explanation:

The keen grain stockpiling the executive's framework comprises of different sensors and microcontroller Node MCU ESP8266. Sensors utilized are DHT11 (Digital Humidity and Temperature), MQ135, MQ2 and PIR sensor. For the controlling activities the signal will give making alerts aware of the merchant. The warning over Blynk applications will be conveyed routinely through Blynk cloud.

b. Programming essentials:



planning. Introduced C to increase the use of C language with some supplementary legend intelligences.

1. Embedded c:

Embedded C is a programming language written in C. Here C is used to connect with a particular equipment

The following diagram represents the proposed system methodology diagram:

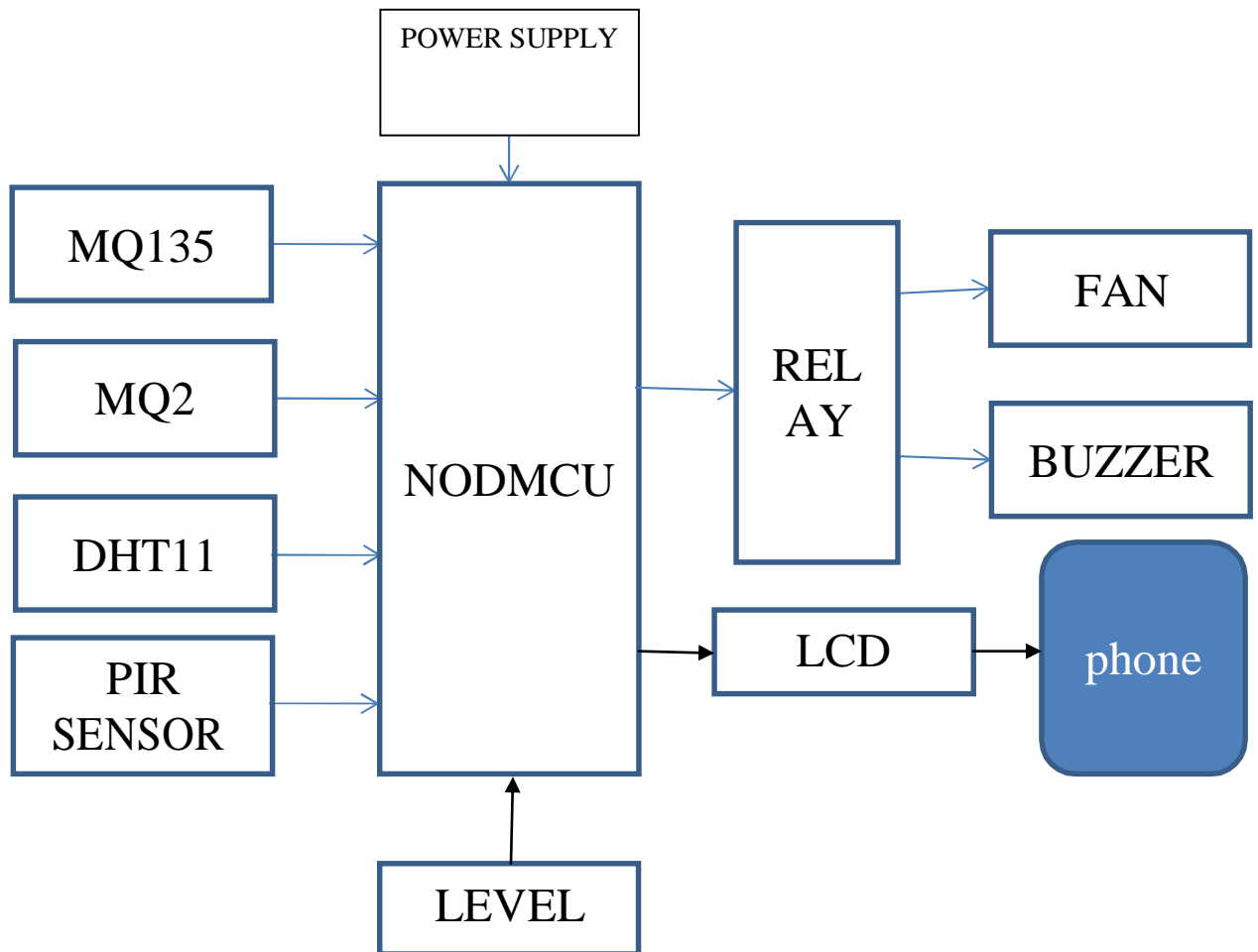

2. Arduino IDE:

Arduino Integrated Development Environment (IDE) is a cross-platform application (for Windows, macOS, Linux) that is written using C and C++. It is used to practice and exchange projects to Arduino supported platforms, with the help of outcast motivations and other merchant platforms.



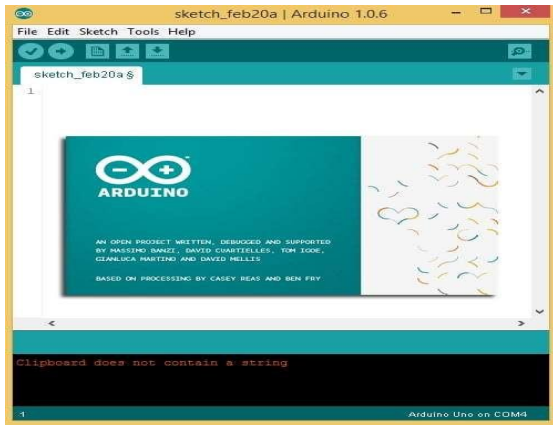

3. Blynk cloud Server:

The Blynk utility is created through the Blynk stage during the new developments. The product will be having the capacity of advanced thinking and regularly sends warnings through the Blynk cloud with a fixed time stamp. Blynk is a Platform consisting of IOS and Android applications to control Arduino, Raspberry Pi and the preference is over the Internet. It is a hi-tech control panel using which it is possible to construct an image interface for your endeavor by utilizing the hauling and shedding widgets. The product will be state-of-the-art regularly through the notices dispatched throughout Blynk cloud with positive time stamp.



III. LITERATURE SURVEY:

2796

- Researchers namely, Vinayaka and Roopa had projected a structure aimed at observing then monitoring the grain conditions. Grain factor called stockpiling house remains essentially towards supply secure accumulating circumstance and to hold up with nature of set aside thing. Grain hardship happens with the guide of negative natural specifications and from the exercise schedules of frightening little animals and microorganisms.

- The standard life sized model proposed for grain accumulating gadget contained two areas, one is the host PC what gathers Grain nearby climate for example Sensor data, it approach and decide of grain circumstance, the distinctive one decline stage control terminal in the storage facility/station with grain records getting. Hence, the proposed structure comprises of the usage of ARM7 processor, LPC2148 and an assortment of sorts of sensors. The limits like temperature, wetness and carbon dioxide charge is demonstrated on the interface. Expecting the attributes are over sure confine conditions, controlling strikes are made actually.

- The maker Can Burak Sisman and Selcuk ALBUT states that, it is trying to work on the idea of set aside grain then again holding up with its fundamental astounding must be conceivable. At the factor when country of set aside grain gets going developed spoiling, it is ordinarily the blend eventual outcome of unmistakable organization exercise schedules that involve basic country of grain, temperature and suddenness development, air course and gazing at grain condition. Grain shop magnificent on the off chance that they are cool, dry and clean.

a. Issue declaration

- Throughout the capacity time body (e.g., air dissemination, drying, fumigation, overseen environments, grain protectants).

b. Targets

- All through the particle amassing, heat, wetness and carbon dioxide main focus remain broad barometrical components that know how to affect the idea of the set aside grain



through the internal the warehouses and circulation focuses. The set up methodologies are controlled to just looking at the temperature and tenacity requirements which are very in converse as extraordinary components must be checked and found uninhibitedly for including to their beneficial accumulating and backing.

IV. Implementation DETAILS:

1. Coding depiction:

□ void arrangement (): This is the area where a client can instate every one of the factors that will be needed over the span of programming a framework. As the name recommends, this capacity is utilized to set up an Arduino prior to interfacing it with different circuits. This region can likewise be utilized to incorporate libraries of different sensors. The prevalently utilized capacities in void arrangement are:

- pinMode: This capacity is utilized to announce pins of Arduino as information or yield.
- serial.begin: This capacity is utilized when Arduino is speaking with different sensors or gadgets. This empowers a client to set a particular baud rate for correspondence reason.

□ void circle (): The code written in this space will run again and again except if Arduino is intruded on utilizing a hinder or the USB link is disengaged from the USB port. The various capacities that are frequently utilized in void circle are:

- digitalWrite: This capacity is utilized to make a particular pin on Arduino sensibly HIGH or LOW.
- digitalRead: This capacity is utilized when there is a need to peruse advanced information from a sensor or when we need to control something utilizing a switch/press button.
- AnalogRead: This capacity proves to be useful when we need to peruse simple information from a sensor eg. Simple read is utilized when there is a need to peruse information from a potentiometer.
- AnalogWrite: This capacity is utilized when a client needs to supply simple voltages to a part. The best illustration of simple compose is the point at which the power of LED is controlled utilizing a potentiometer and simple compose work.



Testing

Trial Circumstances

2798

Trial ID	Trial Cases	Probable Result	Real Result	Position
1.	Connect GAS Sensor Arduino to	Sensor Values are read by microcontroller	Detected	Pass
2.	Connect Ultrasonic Sensor Arduino to	Sensor Values are read by microcontroller	Level measured	Pass
3.	Connect temp Sensor Arduino to	Sensor Values are read by microcontroller	Temp monitored	Pass
3.	Connect humidity Sensor to Arduino	Sensor Values are read by microcontroller	Humidity monitored	Pass
4.	Connect	A new form will be displayed.	User going connect through wifi module	Pass
5.	Connected device with	Wifi module is connected to the microcontroller	Wifi module connected	Pass
6.	Connected blynk with app	Wifi module will be connected to blynk	App and microcontroller are connected	Pass



SCREEN SHOTS OF OUTPUT:

1. General

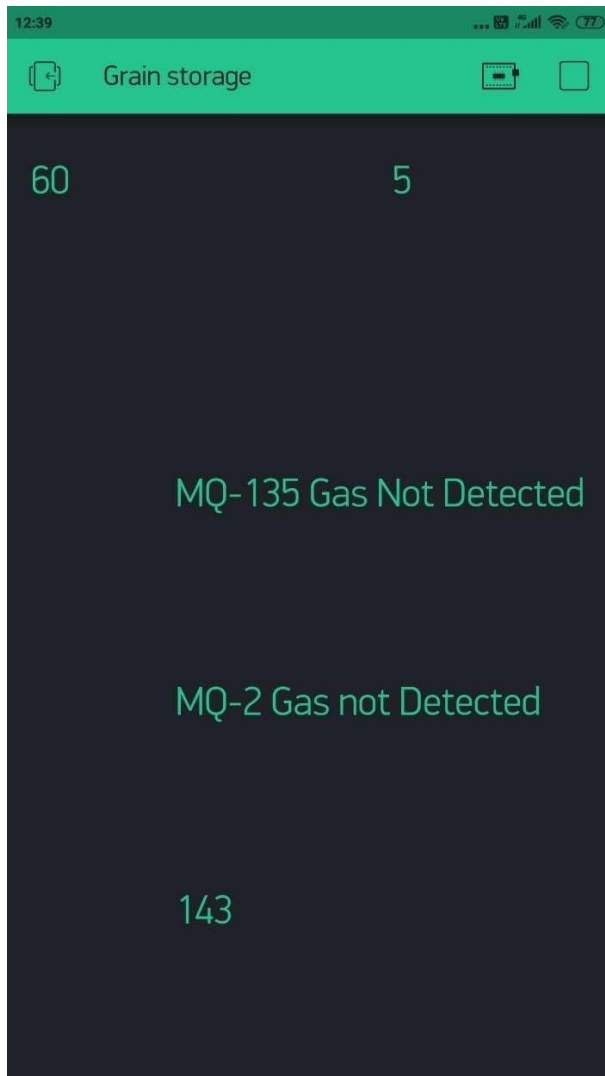

2799



2. Temperature and Humidity:

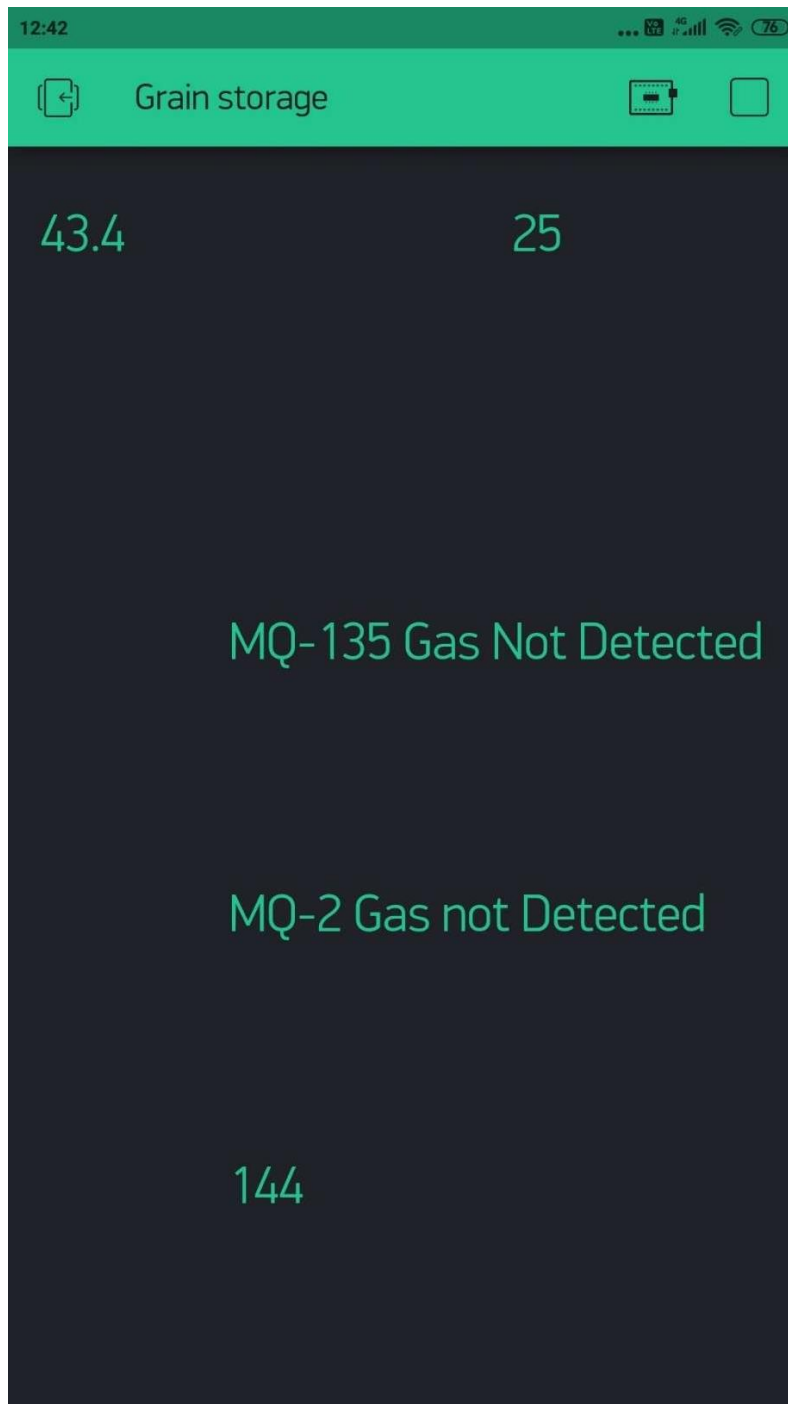

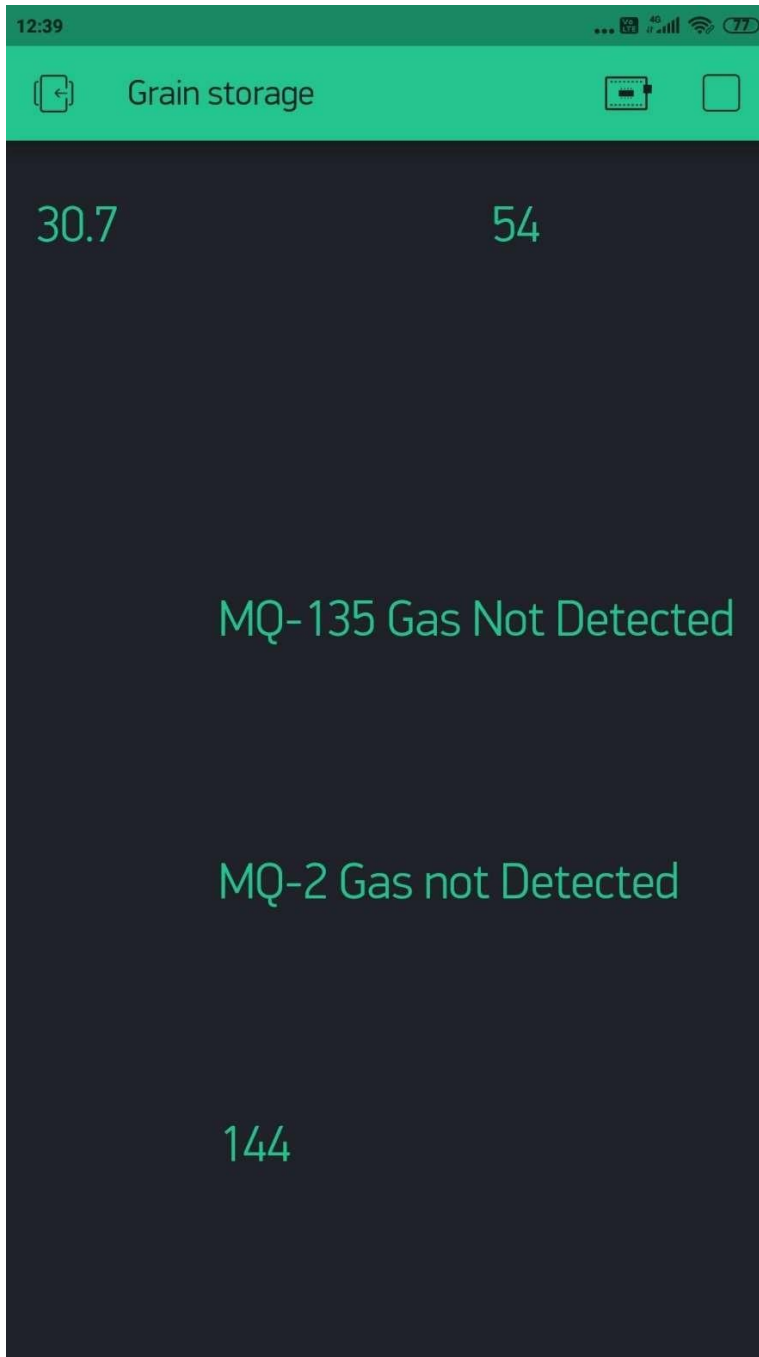

3. Gas Sensor:

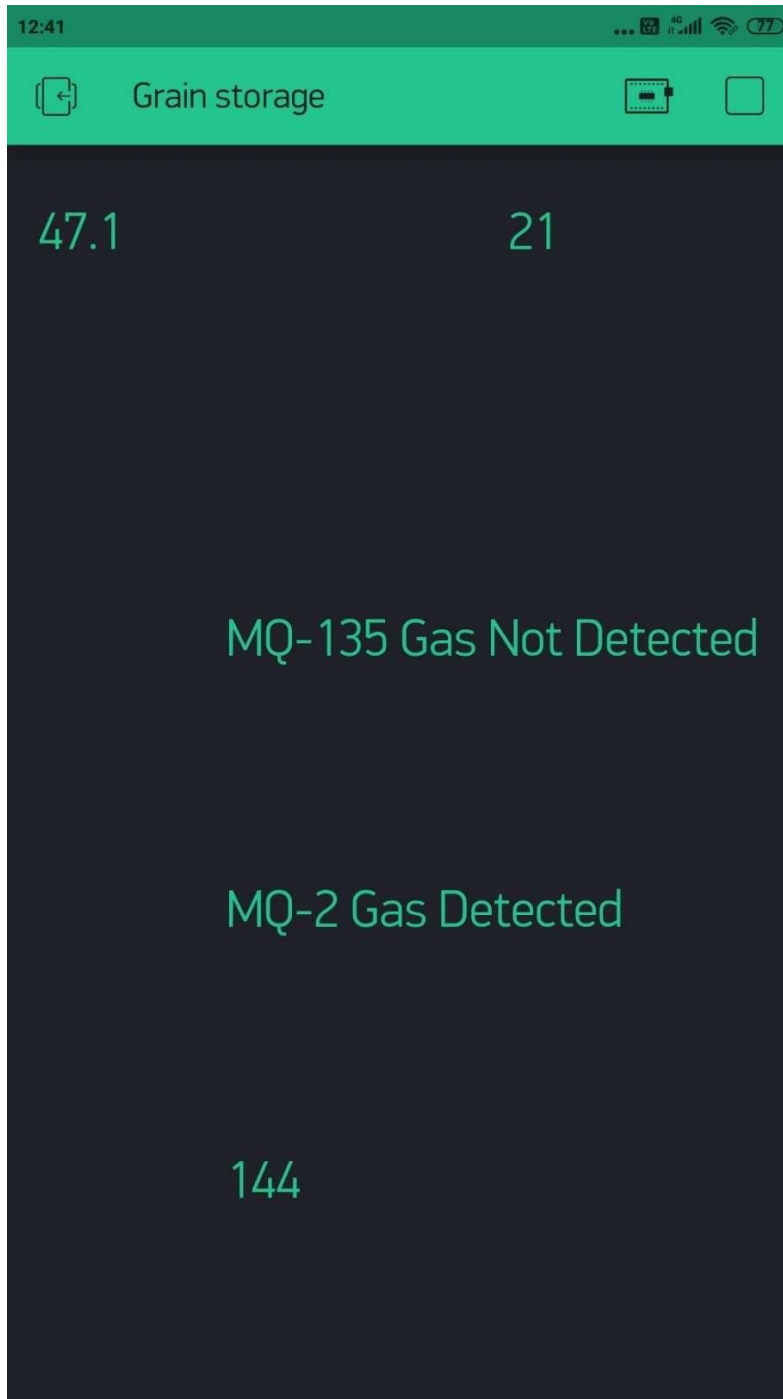

4. Gas Sensor:

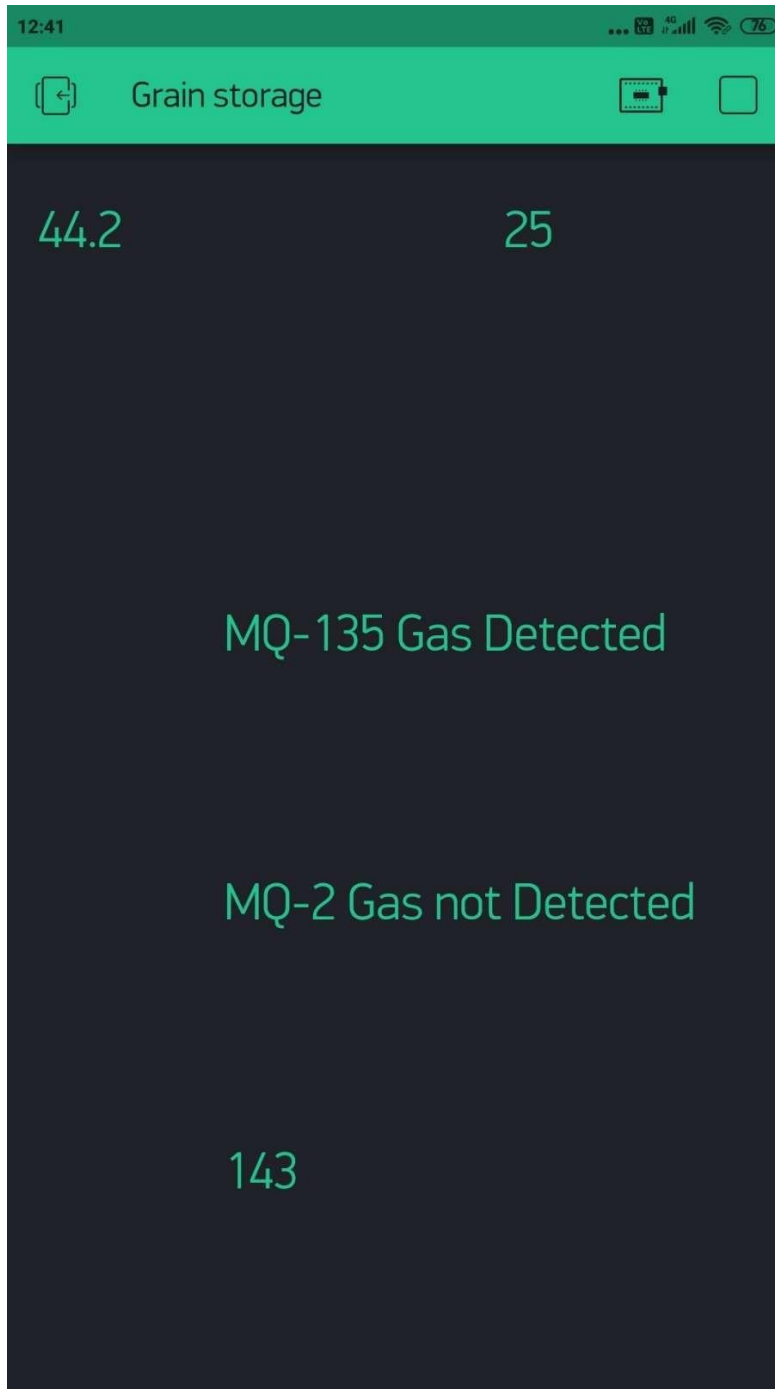

2803



5. Level Storage:

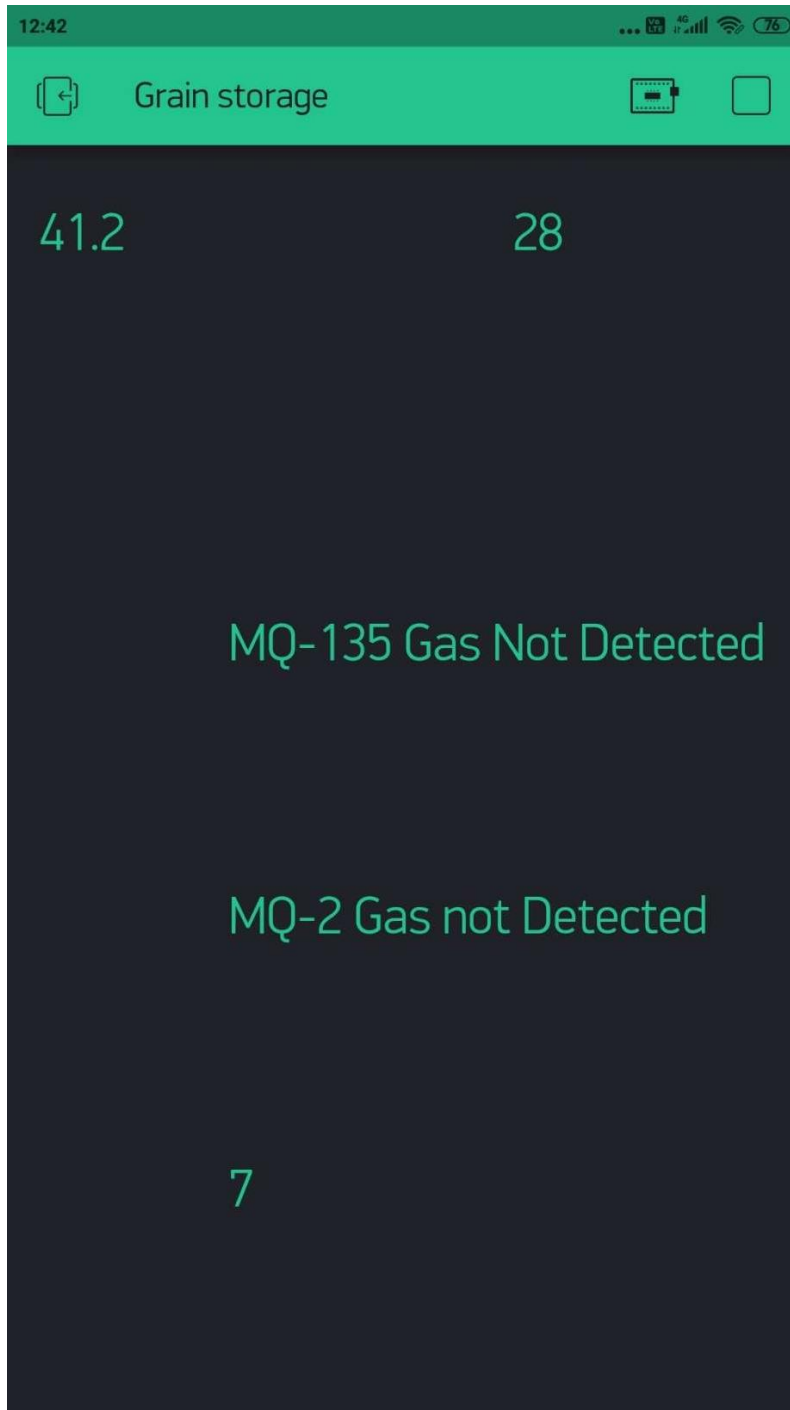

2804



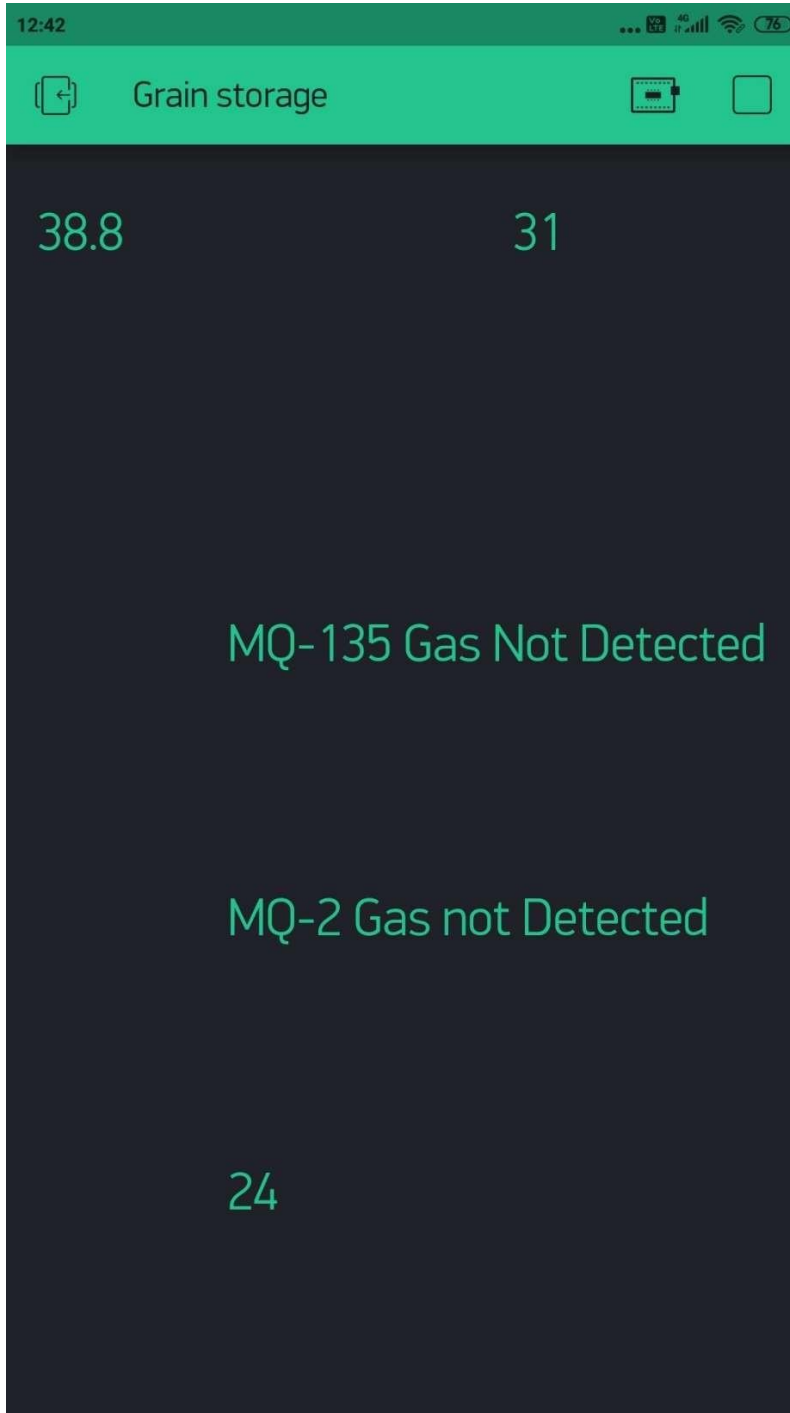

V. CONCLUSION AND FUTURE SCOPE

The undertaking Intelligent Grain collecting framework prompts the model and the sensible arrangement over the issue of grain hoarding the board and the wastage emerges because of not taking the bona fide upkeep. From this point forward, toward the fruition of the undertaking the issues worried with limit and the heads of grain will be taken out to exceptional degree and the framework can be remained mindful of a legitimate standard condition and with inconceivable levels. Also, after acknowledgment of framework, it can satisfactorily diminish the put away grain difficulties up to 80%. At long last, the food receptiveness to individuals in outrageous conditions and if there should arise an occasion of standard catastrophes is the moto of government and this undertaking will in actuality assist with satisfying that moto with less manual endeavors and with greater ability.



VI. CITATIONS OF SOURCE INFORMATION

- [1] Vinayaka , Roopa “Intelligent System for Monitoring and Controlling Grain Condition Based on ARM 7 Processor”, PG Student in VLSI Design and Embedded System, Assistant Professor, Dept. Electronics and Communications, R.V College of engineering Bengaluru, India.
- [2] Can BurakSisman, Selcuk ALBUT “Grain Storage Management”, Namık Kemal Univ. Agricultural Faculty, Farm Constructions and Irrigation Dept. Tekirdag/Turkey
- [3] Shreyas S , ShridharKatgar, Manjunath Ramaji, Yallaling Goudar, Ramya Srikanteswara “Efficient Food Storage Using Sensors, Android and IoT”, Student B.E, Department of CS&E Assistant Professor, Department of CS&E , ramya.srikanteswara@nmit.ac.in NitteMeenakshi Institute Of Technology, Bengaluru.
- [4] A. Akila, P. Shalini“Food grain storage management system”, Department of Computer Science, Vels Institute of Science Technology and Advanced Studies(VISTAS), Chennai, India. Department of MBA, Vels Institute of Science Technology and Advanced Studies (VISTAS), Chennai, India. Corresponding author E-mail:akila.scs@velsuniv.ac.in
- [5] Krushnali D. Bhosale, Renuka M. Chavan, Harshada D. Patil, Prof.Anagha Deshpande “A novel approach for grain storage systems”, Dept of E&TC MITCOE, International Journal of Advance Engineering and Research Development Volume 4, Issue 2, February 2017.
- [6] TSGC, Tri-States Grain Conditioning, Inc., “Grain Temperature Monitoring Systems” www.tsgcinc.com
- [7] <http://www.fao.org/wairdocs/x5002e/X5002e02.htm>
- [8] Grain Storage Systems: book by B. K. Bala, published on 11 November 201

