



CONTROLLING OF SPLIT PHASE INDUCTION MOTOR BY USING CYCLO CONVERTER

¹R.Sandeep Guptha,²P.Odelu Yadav,³J.Venu Madhav

Department Of EEE

Sree Chaitanya College of Engineering, Karimnagar

ABSTRACT

Induction motors with a single phase are extensively used in several applications. Enhancements in its functionality result in significant reductions in the use of electrical power. An example of this kind of improvement is a variable frequency motor supplied by a cycloconverter. In this sense, the research analyses the split phase induction motor's performance and speed control when it is supplied using a cycloconverter. There are provided dynamic models and a study of the motor behaviour in both transient and steady state phases. A cycloconverter-based speed controller is suggested. In the gazing condition, the regulated motor performed better. A cycloconverter is a device that, without the need for a direct current (DC) stage in between, transforms AC power at one frequency into AC power at a variable but lower frequency. It comprises silicon-controlled rectifiers and is also referred to as a static frequency changer. The circuit is implemented using Simulink Tool Box and Simpower System, and the entire circuit is modelled and simulated using MATLAB2012A software. The circuit is simulated under a power graphical user interface, and it is modelled and simulated to obtain the necessary characteristics.

DOI Number: 10.48047/NQ.2022.20.12.NQ77767

NeuroQuantology2022;20(12): 4417-4426

4417

INTRODUCTION

A cycloconverter is an electronic device that converts AC power at a certain frequency to AC power at a different frequency. It can be used to control the speed of an induction motor, among other applications.

A split-phase induction motor is a type of AC motor that is commonly used in low-power applications such as fans and household appliances. It consists of two windings, a main winding and an auxiliary winding, that are placed at a 90-degree angle to each other. The main winding provides the majority of the torque, while the auxiliary winding provides a starting torque to help the motor get going.

When a cycloconverter is used to control the speed of a split-phase induction motor, it can adjust the frequency of the power supplied to the motor, which in turn adjusts the speed of

the motor. This type of control is particularly useful in applications where precise control over the motor speed is required, such as in industrial settings.

A cycloconverter-controlled split-phase induction motor is a type of motor control system that uses a cycloconverter to adjust the frequency of the AC power supplied to the motor. The split-phase induction motor is a common type of AC motor that is widely used in low power applications.

In a split-phase induction motor, the stator winding is divided into two parts, a main winding and an auxiliary winding. The main winding is connected directly to the AC power source, while the auxiliary winding is connected through a capacitor. The capacitor causes the auxiliary winding to have a phase shift relative to the main winding, which creates a rotating magnetic field in the motor. This rotating

www.neuroquantology.com



magnetic field causes the rotor to spin, producing mechanical work.

A cycloconverter is an electronic circuit that converts AC power from one frequency to another. By using a cycloconverter to adjust the frequency of the AC power supplied to the motor, the speed of the motor can be controlled. This allows the motor to operate at a wide range of speeds without the need for additional mechanical speed control devices such as gears or belts.

The use of a cycloconverter-controlled split-phase induction motor has several advantages over other types of motor control systems. For example, it is simpler and more cost-effective than other types of motor control systems, it can operate at a wide range of speeds, and it can provide precise control over the motor's speed and torque.

LITERATURE SURVEY

Maamoun, H.A.; Analogy Inc., Beaverton, OR, USA; Hefner, Allen R. An electrothermal network simulation methodology is used to analyze the behavior of a fullbridge, pulse-width modulated (PWM), voltage-source inverter, which uses insulated gate bipolar transistors (IGBTs) as the switching devices. The electrothermal simulations are performed using the Saber circuit simulator and include control logic circuitry, IGBT gate drivers, the physics based IGBT electrothermal model, and thermal network component models for the power-device silicon chips, packages, and heat sinks. That the thermal response of the silicon chip determines the IGBT temperature rise during the device switching cycle. The thermal response of the device TO247 package and silicon chip determines the device temperature rise during a single phase of the 60-Hz sinusoidal output. The winding insulation of low-voltage induction motors in an adjustable speed drive system with IGBT pulse width modulated (PWM) inverters is substantially stressed due to the uneven voltage distribution and excessive voltage stress (dv/dt), which result in the premature insulation breakdown. In this paper, the detailed insulation test results of 48 low

voltage induction motors are presented. Different types of insulation techniques are applied to 48 motors.

Don-Ha Hwang:- IGBT PWM inverter has been concerned that insulation breakdown and irregular voltage distribution on stator winding due to high rate of voltage rise (dv/dt) caused by high-frequency switching and impedance mismatch between inverter and motor. In this paper, voltage distribution in stator windings of induction motor driven by IGBT PWM inverter is studied. To analyze the irregular voltage of stator winding, high frequency parameter is computed by using finite element method (FEM). An equivalent circuit composed by distributed capacitances, inductance, and resistance is derived from these parameters. This equivalent circuit is then used for simulation in order to predict the voltage distribution among the turns and coils. Also, the thermal response of the heat sink determines the device temperature rise during the system startup and after load-impedance changes. It is also shown that the full electrothermal analysis is required to accurately describe the power losses and circuit efficiency Don-Ha Hwang. . It is also shown that the full electrothermal analysis is required to accurately describe the power losses and circuit efficiency Don-Ha Hwang. The variable effect on rising time of the inverter and cable length on the voltage distribution is also presented. In order to experiment, an induction motor, 50 HP, with taps from one phase and a switching surge generator were built to consider the voltage distribution.

PROPOSED SYSTEM

Split phase induction motor has two windings its stator, a main winding and an auxiliary winding or starting winding. The starting winding is located 90° electrical from the main winding and operates for a short time when the motor starts up. The two windings are so designed that the starting winding has a high resistance and relatively small reactance while the main winding has relatively low resistance and large reactance. This can be done by



having main winding of large diameter and number of turns while starting winding of a fine wire of a small number of turns. The currents taken by these two windings are out of phase

(25 degrees to 30 degrees) Schematic diagram and phasor diagram of split phase induction motor.

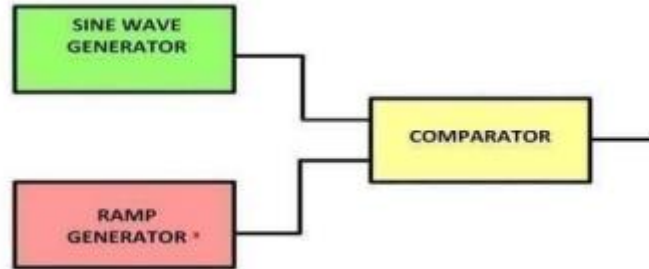

Fig.1: PWM Block Diagram

The (ON time + OFF time) time of the pulse as constant. The (ON time + OFF time) of a pulse is called 'Period' of the pulse, and the ratio of the ON time or OFF time with the Period is called the 'Duty Cycle'. Hence the PWM is a kind of modulation which keeps the Period of pulses constant but varying their duty cycle according to the amplitude of the modulating signal. The conventional method of generating a PWM modulated wave is to compare the message signal with a ramp waveform using a comparator. The block diagram required for the generation of a simple PWM.

Characteristics of Split-Phase Induction Motor

1. The starting torque is 1.5 to 2 times the full load torque and the starting current is 6 to 8 times the full-load current.

2. The power ratings of such motors are from 60 Watts to 250 Watts.
3. They have efficiency of 50 – 70 % and overload of 50%.
4. As they have moderate starting torque and low starting current, so they are commonly used to drive fans, blowers, centrifugal pumps, domestic refrigerators, washing machines, oilburners, small machine tools, etc.
5. These motors are essentially constant-speed motors. The speed variation is 2 to 5 % from no-load to full-load.
6. The speed range of such motors is from 2875 to 700 r.p.m.
7. Such a motor can be operated with a power factor of 0.55 – 0.65.
8. The percent slip for such motors is about 4 – 6 percent.

SIMULATION RESULTS

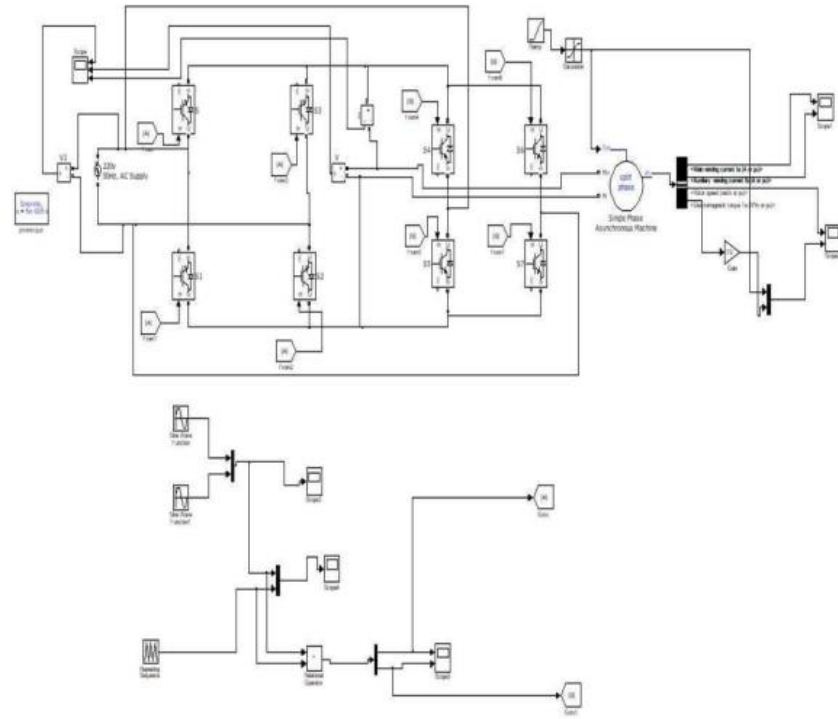
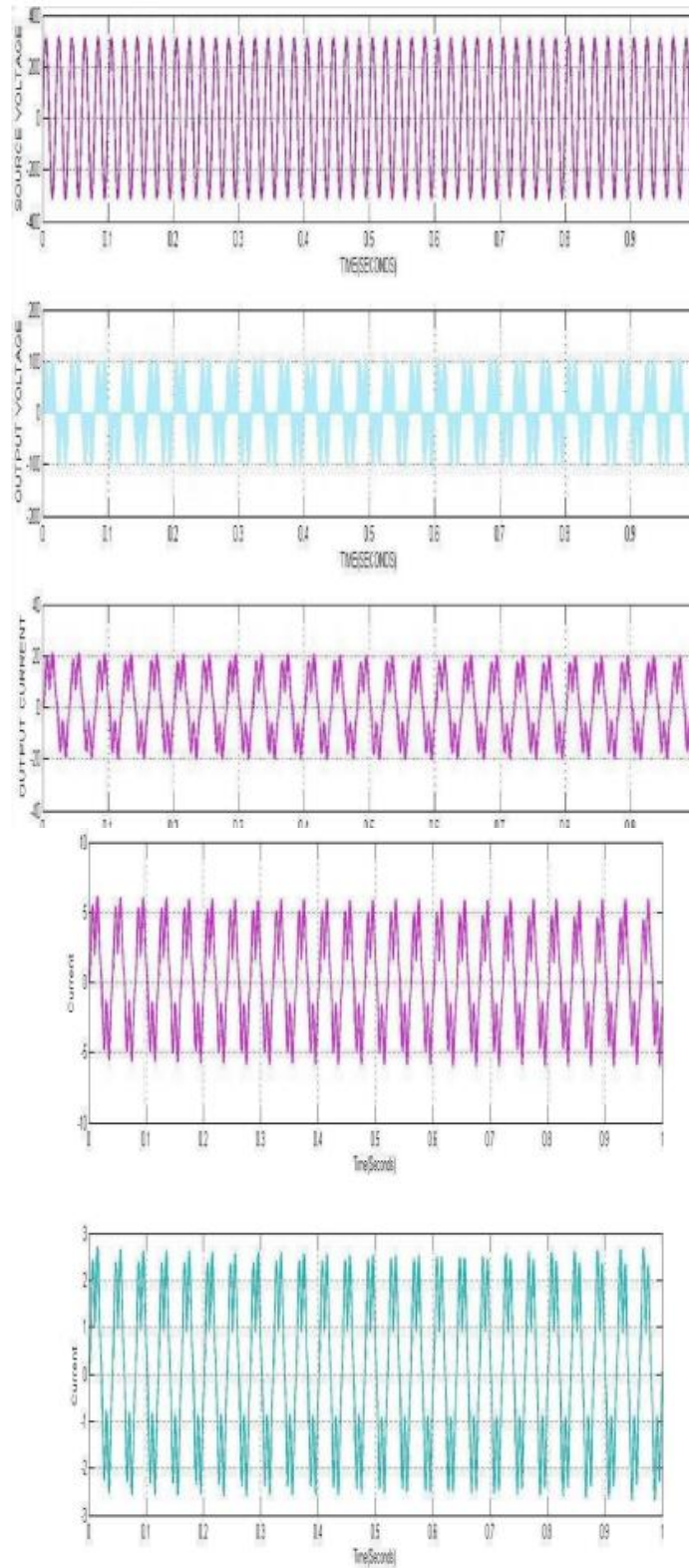

Fig.1: Simulation Diagram



4421

Main Winding Current (b) Auxiliary Winding Current Waveform of Single Phase Induction Motor, When Input Frequency to the Cycloconverter is Two Times Output Frequency



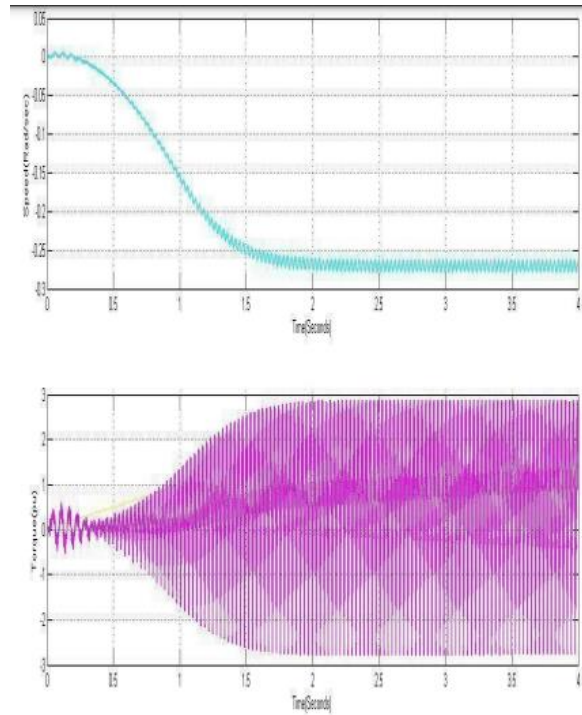

4422

Fig.2: (a) Rotor Speed (b) Load and Electromagnetic Torque Waveform of Single Phase Induction Motor, When Input Frequency to the Cycloconverter is five Times Output Frequency

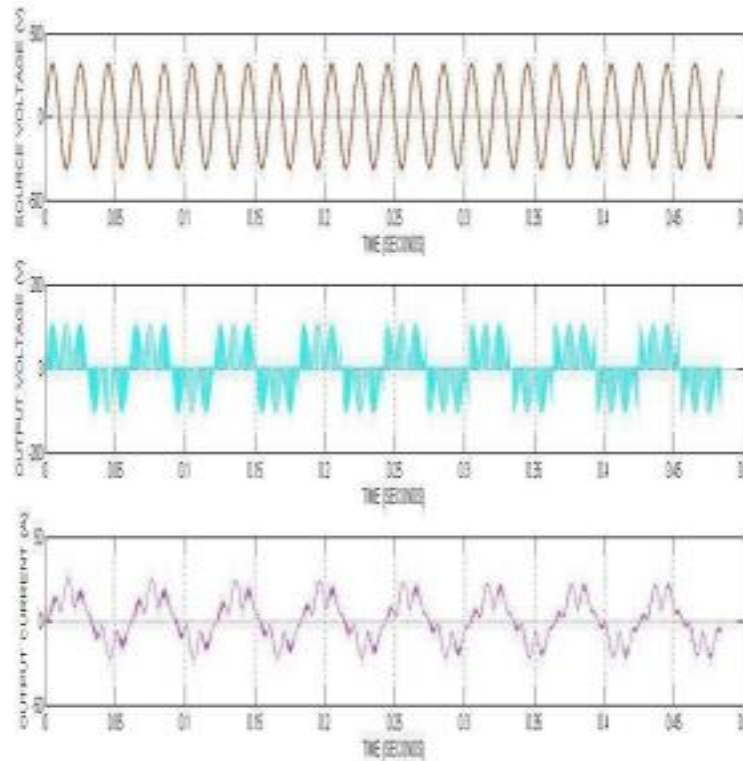

(a) Source Voltage (b) Output Voltage (c) Output current Waveform of Single Phase to Single Phase Cycloconverter When Input Frequency is Three Times Output Frequency.



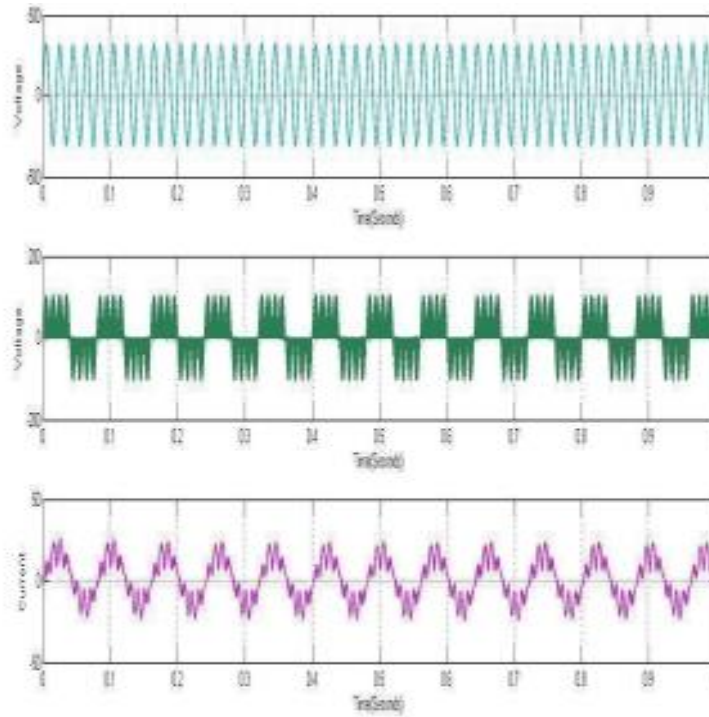

(a) Source Voltage (b) Output Voltage (c) Output current Waveform of SinglePhase to Single Phase Cycloconverter When Input Frequency is Four Times OutputFrequency

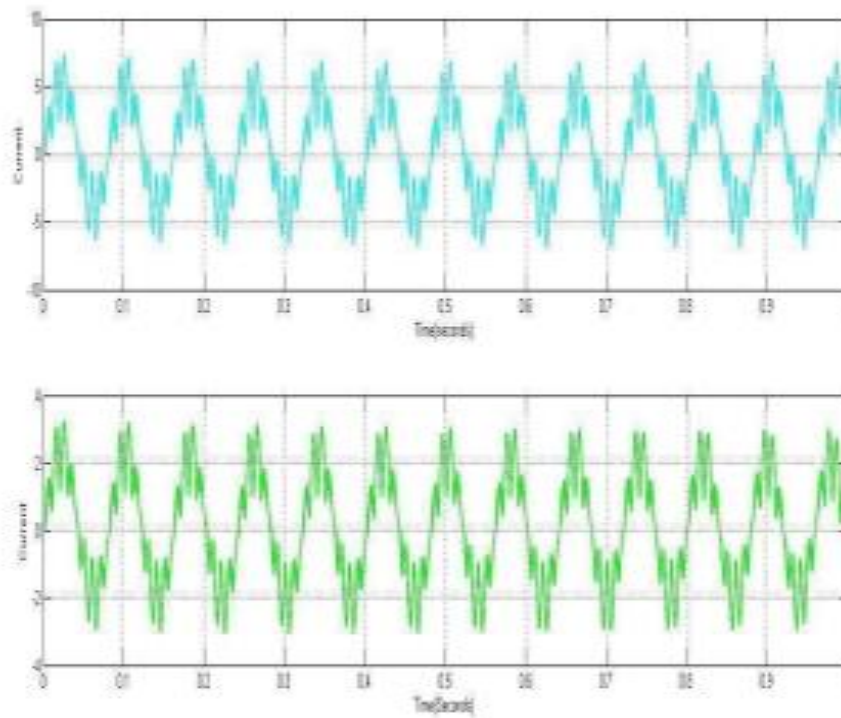

(a) Main Winding Current (b) Auxiliary Winding Current Waveform of SinglePhase Induction Motor, When Input Frequency to the Cycloconverter is Four Times Output Frequency.

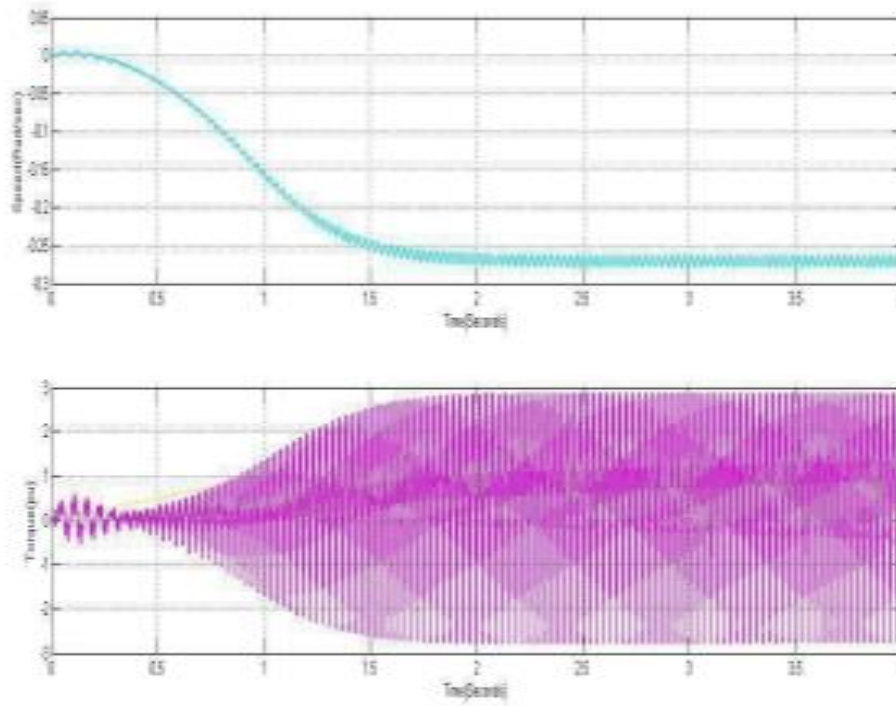

4424

a) Rotor Speed (b) Load and Electromagnetic Torque Waveform of SinglePhase Induction Motor, When Input Frequency to the Cycloconverter is Four Times Output Frequency.

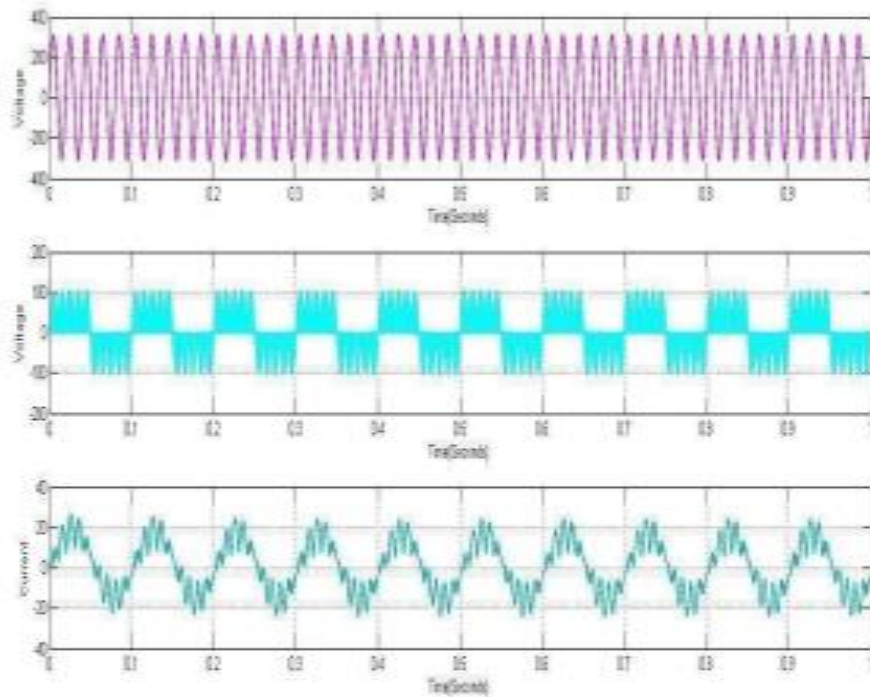

(a) Source Voltage (b) Output Voltage (c) Output current Waveform of Single Phase to Single Phase Cycloconverter When Input Frequency is Five Times Output Frequency.



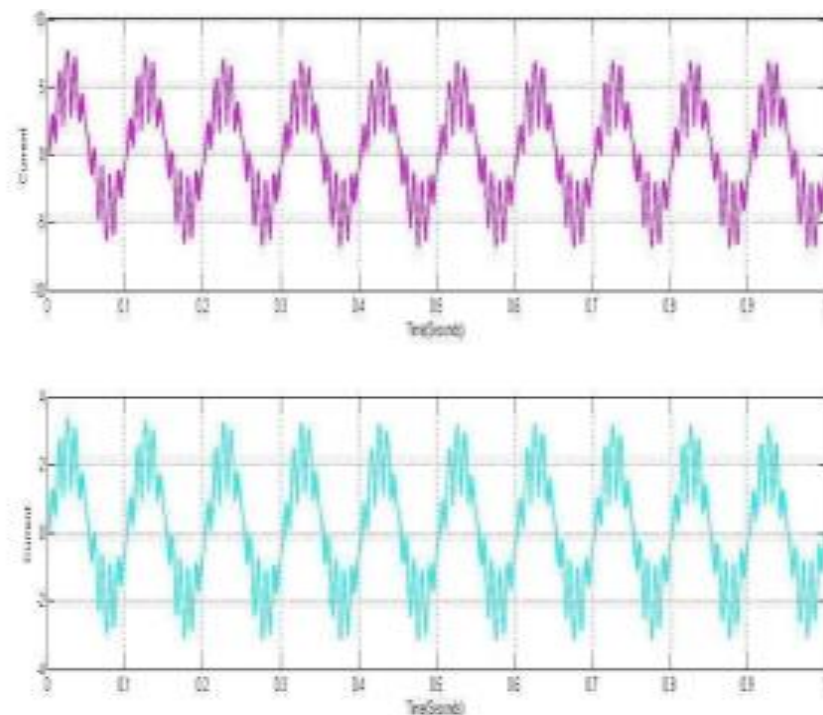

(a) Main Winding Current (b) Auxiliary Winding Current Waveform of SinglePhase Induction Motor, When Input Frequency to the Cycloconverter is Five Times Output Frequency.

CONCLUSION

The intended outcomes are attained after designing and simulating the PWM driven cycloconverter circuits. By creating a single-phase Cycloconverter with a varied desired frequency, the torque demands of a machine may be equalised. This Cycloconverter is used with a single-phase motor to provide supply torque characteristics that correspond with demand torque characteristics of that specific machine. In order to lessen the source of torsional vibration and fatigue damage to the machine, the Cycloconverter's variable frequency may also be used to replace the flywheel from the running machine. A feedback control technique for a split phase induction motor supplied by a cycloconverter was developed in the study. Moreover, it offers ways to restrict the slip and, in turn, the motor current. Better efficiency and a lower Cycloconverter rating result from this. This

submission will detail the outcomes of a single-phase cycloconverter connected to an induction motor using Matlab.

REFERENCES

1. Maamoun, A., "Development of cycloconverters," Canadian Conference on Electrical and Computer Engineering, 2003. IEEE CCECE Vol.1,4-7, pp.521 – 524 May 2003.
2. Sandeep Pande , Harshit Dalvi, "Simulation of Cycloconverter Based Three Phase Induction Motor" International Journal of Advances in Engineering & Technology (IJAET), ISSN: 2231-1963 Vol. 1, Issue 3, pp.23-33 July 2011.
3. Shlomi Eitan and Raul Rabinovici, "On Line Simulation Models of Electric Drives" Proceedings of International Conference on Electrical Machines,

2008, 978-1-4244-1736-0/08, pp. 1-6
IEEE 2008.

4. Azharuddin Idris, Mustafar Kamal Hamzah, and NgahRamzi Hamzah "Modelling & Simulation of a new Single-phase to Single-phase Cycloconverter based on Single-phase Matrix Converter Topology with Sinusoidal Pulse Width Modulation Using MATLAB/Simulink" pp.1557-1562 IEEE PEDS 2005.
5. Taufik Taufik , Jesse Adamson and Anton Satria Prabuwno "Pulse Density Modulated SoftSwitching Single-Phase Cycloconverter" IEEE Applied Power Electronics Colloquium (IAPEC), pp.189-194, 2011.

